



Manufactured By: 

DISCOVER

# TRADITIONAL STYLE GARAGE DOORS

TIMELESS DESIGNS FOR EVERY HOME



[PenguinGarageDoors.ca](http://PenguinGarageDoors.ca)



[PenguinGarageDoors@gmail.com](mailto:PenguinGarageDoors@gmail.com)



647-621-3331



# 3610

INSULATED SANDWICH



Traditional Raised Panel 3 Layer Sandwich

RAISED PANELS



↑ SANDSTONE



↑ WHITE

## Traditional Raised Panel

2" thick insulated steel sandwich panel constructed of top quality materials. Highly detailed raised panel, deep woodgrain texture, and two coat prefinished paint system all combine to enhance the beauty of your home.

- 2" thick insulated 3 layer sandwich panel
- 1.0 mil paint with 7 color options
- 8 window options
- R-value 10.25
- Steel interior skin



WHITE



ALMOND

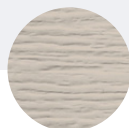

DESERT TAN

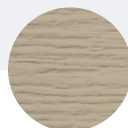

SANDSTONE

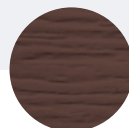

BROWN

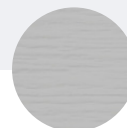

GRAY



BLACK

\*Colors may vary from actual product

### FEATURES

- 
**26 GAUGE STEEL**  
 Hot dipped galvanized steel construction with hemmed inside return rail provides superior strength and durability.
- 
**20 GAUGE HOT DIPPED STEEL HINGE PLATES**  
 Galvanized steel hinge plates run the full height of each section at all hinge locations to facilitate the attachment of hinges, handles, struts, and step plates.
- 
**TONGUE AND GROOVE MEETING RAILS**  
 For superior strength and better sealing against wind, rain, and snow.
- 
**RIGID ALUMINUM RETAINER WITH WEATHERSTRIP**  
 Provides added strength while securing replaceable U-type bottom astragal weatherstrip to help keep the elements out.
- 
**R-VALUE 10.25**  
 Sandwich type construction with polystyrene insulation pressure bonded between two sheets of hot dipped galvanized steel enhances your home's energy savings, makes your door operation quieter, and reduces exterior noise in your garage.
- 
**CFC FREE EXPANDED POLYSTYRENE**  
 Environmentally friendly insulation that will not degrade with vibration or time.

### WINDOW GLASS OPTIONS

Contact your supplier for window options

### SIZE OPTIONS

#### WIDTHS:

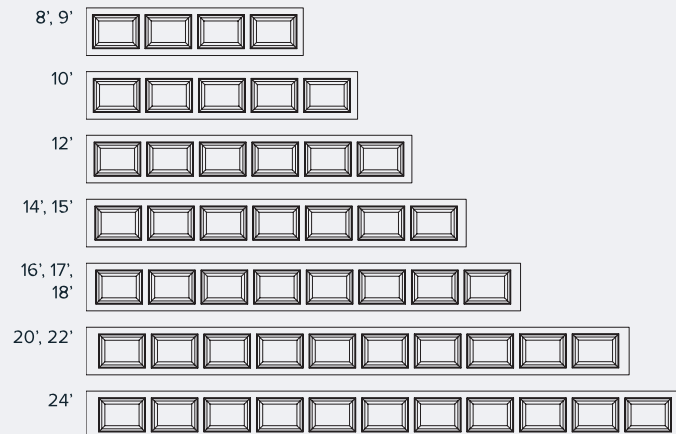

HEIGHTS: 6'6", 6'9", 7'0", 7'6", 7'9", 8'0"

### WINDOW OPTIONS

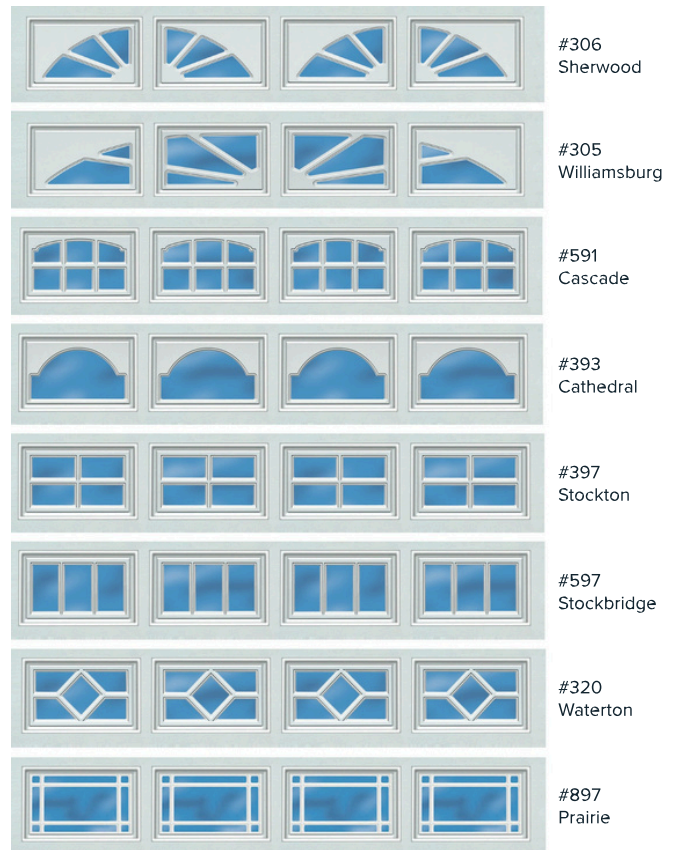

\*Not all glazing options may be available from all distributors. No glazing on 18" sections.

### PAINT LAYERS

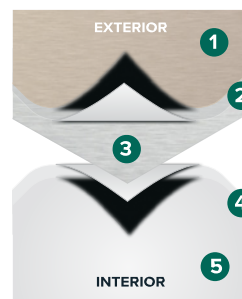

### 1.0 MIL PAINT SYSTEM

Includes .25 mil rust inhibiting primer and .75 mil exterior top coat that resists fading and chalking, while providing consistent color from panel to panel and more durability.

- 1 Paint - .75 MIL
- 2 Primer - .25 MIL
- 3 Steel
- 4 Primer - .2 MIL
- 5 Paint - .3 MIL

### CONSTRUCTION

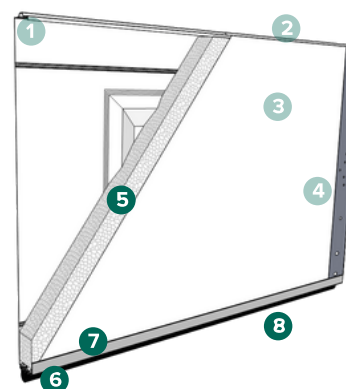

- 1 Tongue and groove meeting rails
- 2 2" thick section
- 3 Pebble grain embossed interior backskin
- 4 20 gauge hot dipped galvanized steel end caps
- 5 CFC free expanded polystyrene insulation
- 6 Replaceable U-Type vinyl bottom weatherstrip
- 7 20 gauge full vertical steel hinge plate for hardware attachment
- 8 Extruded aluminum weatherstrip retainer



# 3690

INSULATED SANDWICH



Manufactured By: **doorLink** Manufacturing, Inc.

**Raised Ranch Panel 3 Layer Sandwich**

**RAISED PANELS**

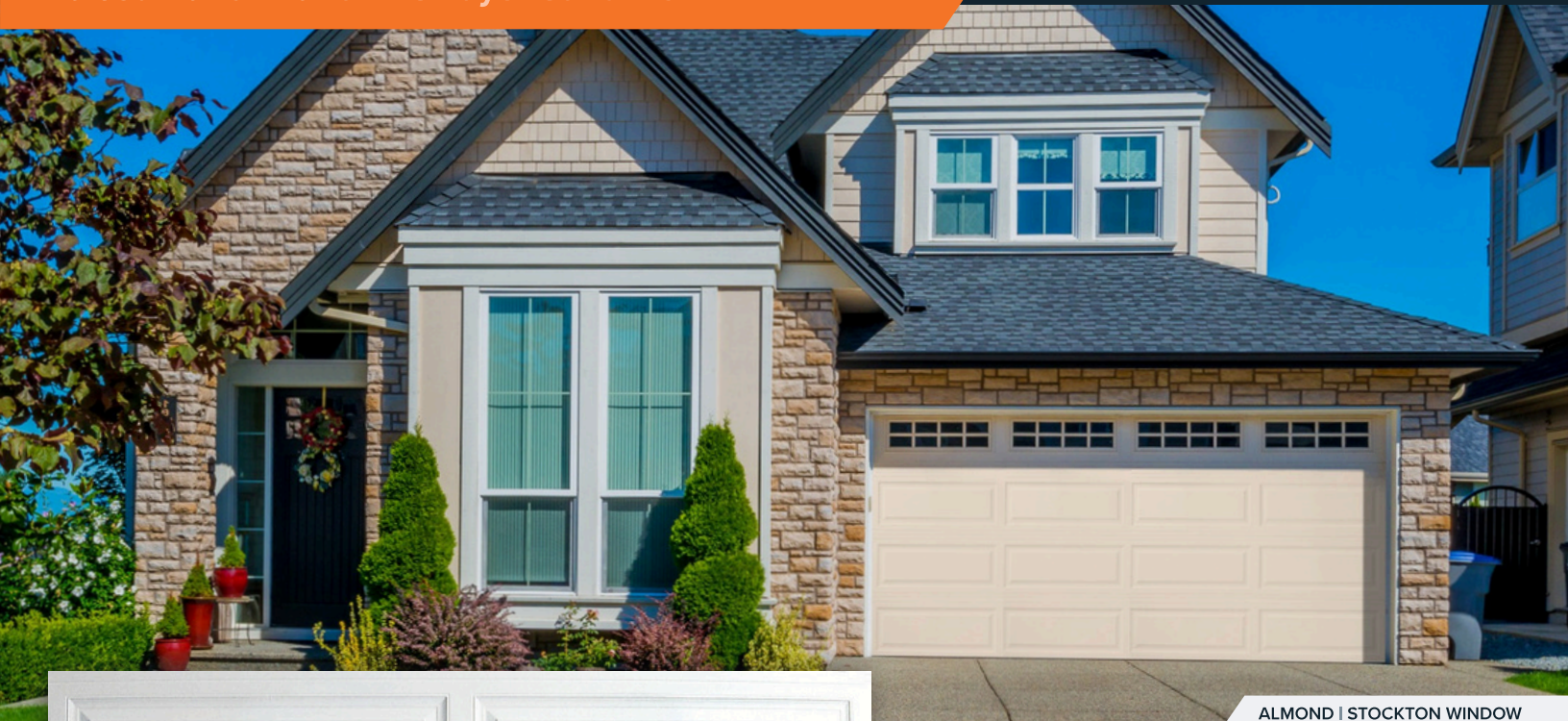

ALMOND | STOCKTON WINDOW



## Raised Ranch Panel

2" thick insulated steel sandwich panel constructed of top quality materials. Highly detailed raised ranch panel, deep woodgrain texture, and two coat prefinished paint system all combine to enhance the beauty of your home.

- 2" thick insulated 3 layer sandwich panel
- 1.0 mil paint with 7 color options
- 6 window options
- R-value 10.25
- Steel interior skin

WHITE



WHITE



ALMOND



DESERT TAN



SANDSTONE

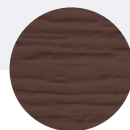

BROWN

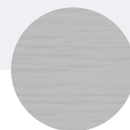

GRAY



BLACK

*\*Colors may vary from actual product*



### FEATURES

- 

**26 GAUGE STEEL**  
Hot dipped galvanized steel construction with hemmed inside return rail provides superior strength and durability.
- 

**20 GAUGE HOT DIPPED STEEL HINGE PLATES**  
Galvanized steel hinge plates run the full height of each section at all hinge locations to facilitate the attachment of hinges, handles, struts, and step plates.
- 

**TONGUE AND GROOVE MEETING RAILS**  
For superior strength and better sealing against wind, rain, and snow.
- 

**RIGID ALUMINUM RETAINER WITH WEATHERSTRIP**  
Provides added strength while securing replaceable U-type bottom astragal weatherstrip to help keep the elements out.
- 

**R-VALUE 10.25**  
Sandwich type construction with polystyrene insulation pressure bonded between two sheets of hot dipped galvanized steel enhances your home's energy savings, makes your door operation quieter, and reduces exterior noise in your garage.
- 

**CFC FREE EXPANDED POLYSTYRENE**  
Environmentally friendly insulation that will not degrade with vibration or time.

### SIZE OPTIONS

**WIDTHS:**

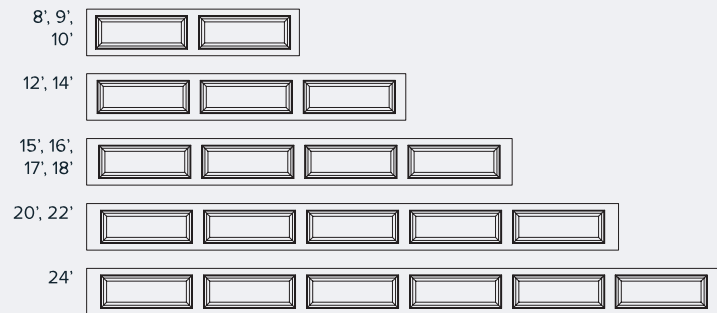

**HEIGHTS:** 6'6", 6'9", 7'0", 7'6", 7'9", 8'0"

### WINDOW OPTIONS

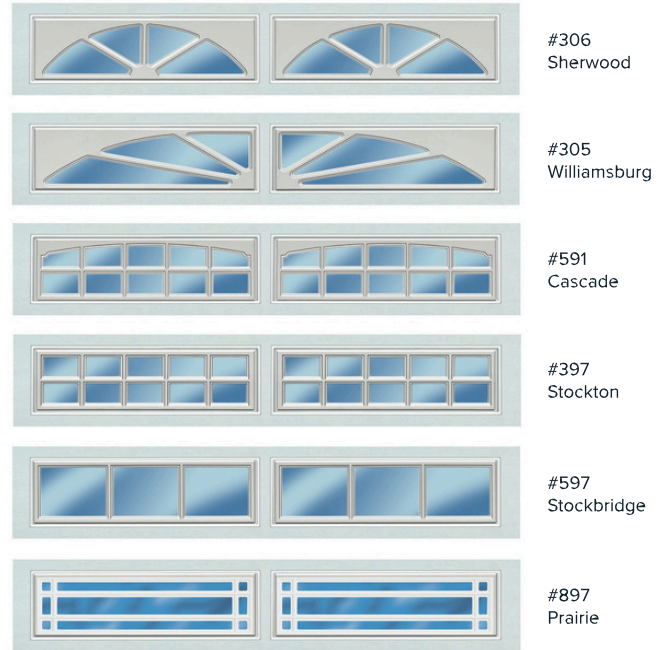

### WINDOW GLASS OPTIONS

Contact your supplier for window options

*\*Not all glazing options may be available from all distributors. No glazing on 18" sections.*

### PAINT LAYERS

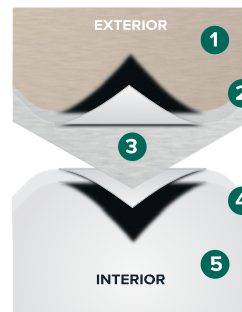

### 1.0 MIL PAINT SYSTEM

Includes .25 mil rust inhibiting primer and .75 mil exterior top coat that resists fading and chalking, while providing consistent color from panel to panel and more durability.

- 1 Paint - .75 MIL
- 2 Primer - .25 MIL
- 3 Steel
- 4 Primer - .2 MIL
- 5 Paint - .3 MIL

### CONSTRUCTION

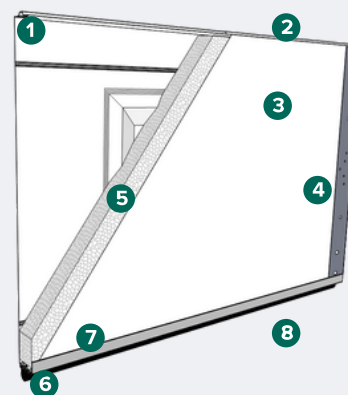

- 1 Tongue and groove meeting rails
- 2 2" thick section
- 3 Pebble grain embossed interior backskin
- 4 20 gauge hot dipped galvanized steel end caps
- 5 CFC free expanded polystyrene insulation
- 6 Replaceable U-Type vinyl bottom weatherstrip
- 7 20 gauge full vertical steel hinge plate for hardware attachment
- 8 Extruded aluminum weatherstrip retainer

# 3630

INSULATED SANDWICH



Manufactured By: **doorLink**  
Manufacturing, Inc.

Grooved Panel 3 Layer Sandwich

CARRIAGE HOUSE PANELS



ALMOND | STOCKTON WINDOW



WHITE | STOCKTON WINDOW

## Grooved Panel

2" thick insulated steel sandwich panel constructed of top quality materials. Highly detailed grooved panel, deep pebble grain texture, and two coat prefinished paint system all combine to enhance the beauty of your home.

- 2" thick insulated 3 layer sandwich panel
- 1.0 mil paint with 10 color options
- 6 window options
- R-value 10.25
- Steel interior skin



WHITE



ALMOND



DESERT TAN



SANDSTONE



BROWN



GRAY



BLACK

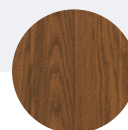

OAK

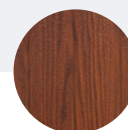

WALNUT

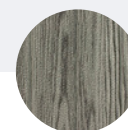

DRIFTWOOD

\*Colors may vary from actual product



#### FEATURES

- 

**26 26 GAUGE STEEL**  
Hot dipped galvanized steel construction with hemmed inside return rail provides superior strength and durability.
- 

**20 GAUGE HOT DIPPED STEEL HINGE PLATES**  
Galvanized steel hinge plates run the full height of each section at all hinge locations to facilitate the attachment of hinges, handles, struts, and step plates.
- 

**TONGUE AND GROOVE MEETING RAILS**  
For superior strength and better sealing against wind, rain, and snow.
- 

**DIRECTIONAL WOOD GRAIN PATTERN**  
Directional wood grain pattern gives the appearance of traditional wood doors.
- 

**RIGID ALUMINUM RETAINER WITH WEATHERSTRIP**  
Provides added strength while securing replaceable U-type bottom astragal weatherstrip to help keep the elements out.
- 

**R-VALUE 10.25**  
Sandwich type construction with polystyrene insulation pressure bonded between two sheets of hot dipped galvanized steel enhances your home's energy savings, makes your door operation quieter, and reduces exterior noise in your garage.
- 

**CFC FREE EXPANDED POLYSTYRENE**  
Environmentally friendly insulation that will not degrade with vibration or time.

#### SIZE OPTIONS

##### WIDTHS:

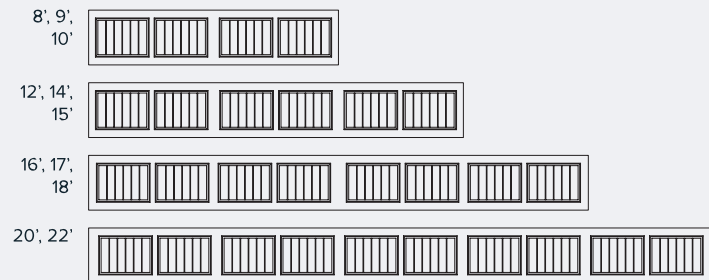

**HEIGHTS:** 6'6", 6'9", 7'0", 7'6", 7'9", 8'0"

#### WINDOW OPTIONS

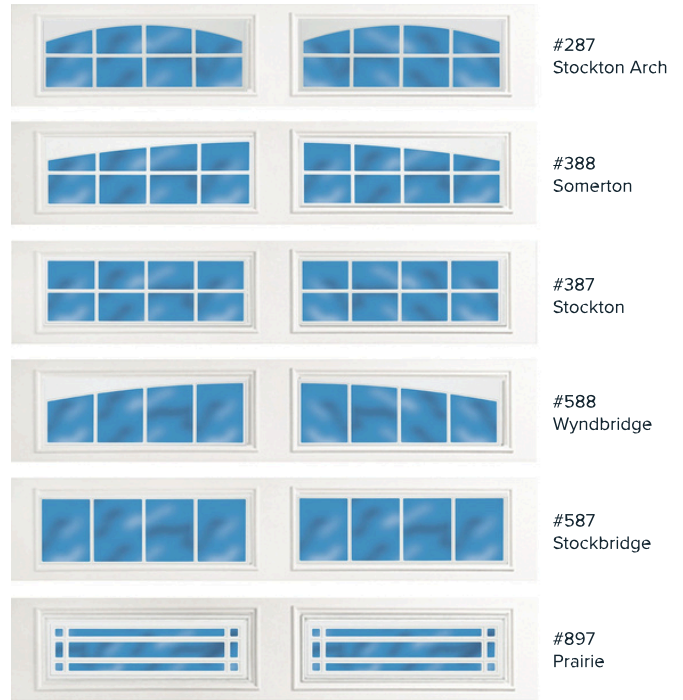

#### WINDOW GLASS OPTIONS

Contact your supplier for window options

*\*Not all glazing options may be available from all distributors. No glazing on 18" sections.*

#### PAINT LAYERS

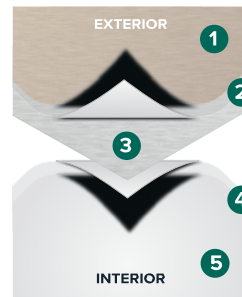

#### 1.0 MIL PAINT SYSTEM

Includes .25 mil rust inhibiting primer and .75 mil exterior top coat that resists fading and chalking, while providing consistent color from panel to panel and more durability.

- 1 Paint - .75 MIL
- 2 Primer - .25 MIL
- 3 Steel
- 4 Primer - .2 MIL
- 5 Paint - .3 MIL

#### CONSTRUCTION

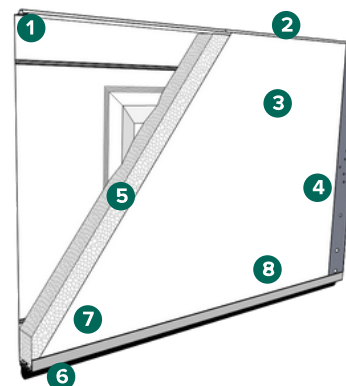

- 1 Tongue and groove meeting rails
- 2 2" thick section
- 3 Pebble grain embossed interior backskin
- 4 20 gauge hot dipped galvanized steel end caps
- 5 CFC free expanded polystyrene insulation
- 6 Replaceable U-Type vinyl bottom weatherstrip
- 7 20 gauge full vertical steel hinge plate for hardware attachment
- 8 Extruded aluminum weatherstrip retainer

# 3640

INSULATED SANDWICH



**PENGUIN**  
GARAGE DOORS INC.



Manufactured By: **doorLink**  
Manufacturing, Inc.

Long Grooved Panel 3 Layer Sandwich

CARRIAGE HOUSE PANELS

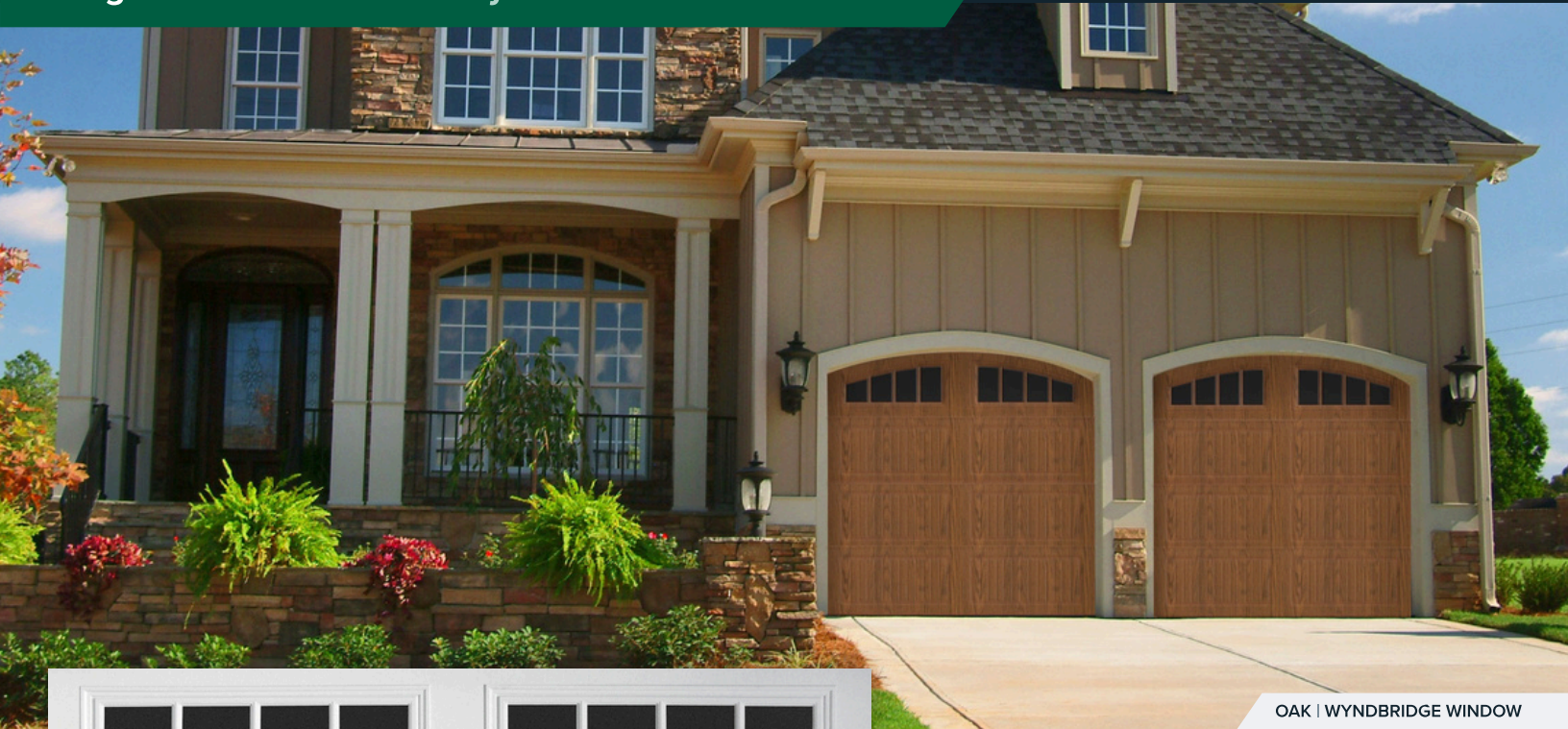

OAK | WYNDBRIDGE WINDOW



WHITE | STOCKTON WINDOW

## Long Grooved Panel

2" thick insulated steel sandwich panel constructed of top quality materials. Highly detailed long grooved panel, deep pebble grain texture, and two coat prefinished paint system all combine to enhance the beauty of your home.

- 2" thick insulated 3 layer sandwich panel
- 1.0 mil paint with 10 color options
- 6 window options
- R-value 10.25
- Steel interior skin



WHITE



ALMOND



DESERT TAN



SANDSTONE



BROWN



GRAY



BLACK

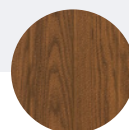

OAK

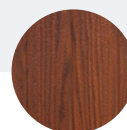

WALNUT

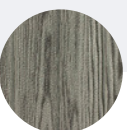

DRIFTWOOD

*\*Colors may vary from actual product*



### FEATURES

- 

**26 GAUGE STEEL**  
Hot dipped galvanized steel construction with hemmed inside return rail provides superior strength and durability.
- 

**20 GAUGE HOT DIPPED STEEL HINGE PLATES**  
Galvanized steel hinge plates run the full height of each section at all hinge locations to facilitate the attachment of hinges, handles, struts, and step plates.
- 

**TONGUE AND GROOVE MEETING RAILS**  
For superior strength and better sealing against wind, rain, and snow.
- 

**DIRECTIONAL WOOD GRAIN PATTERN**  
Directional wood grain pattern gives the appearance of traditional wood doors.
- 

**RIGID ALUMINUM RETAINER WITH WEATHERSTRIP**  
Provides added strength while securing replaceable U-type bottom astragal weatherstrip to help keep the elements out.
- 

**R-VALUE 10.25**  
Sandwich type construction with polystyrene insulation pressure bonded between two sheets of hot dipped galvanized steel enhances your home's energy savings, makes your door operation quieter, and reduces exterior noise in your garage.
- 

**CFC FREE EXPANDED POLYSTYRENE**  
Environmentally friendly insulation that will not degrade with vibration or time.

### SIZE OPTIONS

**WIDTHS:**

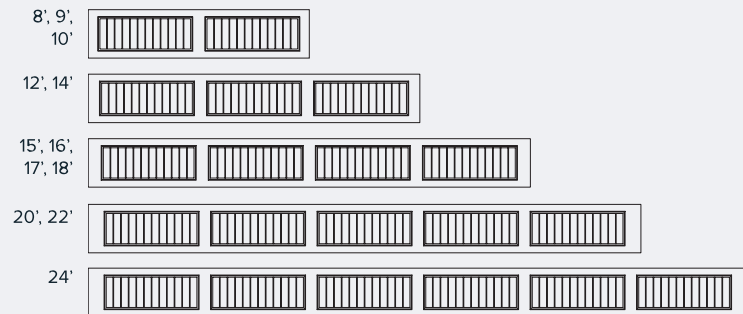

**HEIGHTS:** 6'6", 6'9", 7'0", 7'6", 7'9", 8'0"

### WINDOW OPTIONS



### WINDOW GLASS OPTIONS

Contact your supplier for window options

*\*Not all glazing options may be available from all distributors. No glazing on 18" sections.*

### PAINT LAYERS

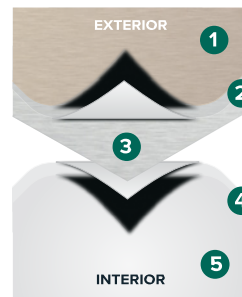

### 1.0 MIL PAINT SYSTEM

Includes .25 mil rust inhibiting primer and .75 mil exterior top coat that resists fading and chalking, while providing consistent color from panel to panel and more durability.

- 1 Paint - .75 MIL
- 2 Primer - .25 MIL
- 3 Steel
- 4 Primer - .2 MIL
- 5 Paint - .3 MIL

### CONSTRUCTION

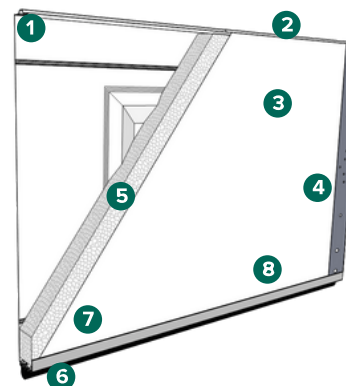

- 1 Tongue and groove meeting rails
- 2 2" thick section
- 3 Pebble grain embossed interior backskin
- 4 20 gauge hot dipped galvanized steel end caps
- 5 CFC free expanded polystyrene insulation
- 6 Replaceable U-Type vinyl bottom weatherstrip
- 7 20 gauge full vertical steel hinge plate for hardware attachment
- 8 Extruded aluminum weatherstrip retainer